

NCP1597A

1 MHz, 2.0 A Synchronous Buck Regulator

The NCP1597A family are fixed 1 MHz, high-output-current, synchronous PWM converters that integrate a low-resistance, high-side P-channel MOSFET and a low-side N-channel MOSFET. The NCP1597A utilizes current mode control to provide fast transient response and excellent loop stability. It regulates input voltages from 4.0 V to 5.5 V down to an output voltage as low as 0.8 V and is able to supply up to 2.0 A.

The NCP1597A includes an internally fixed switching frequency (F_{sw}), and an internal soft-start to limit inrush currents. Using the EN pin, shutdown supply current is reduced to 3 μ A maximum.

Other features include cycle-by-cycle current limiting, short-circuit protection, power saving mode and thermal shutdown.

Features

- Input Voltage Range: from 4.0 V to 5.5 V
- Internal 140 m Ω High-Side Switching P-Channel MOSFET and 90 m Ω Low-Side N-Channel MOSFET
- Fixed 1 MHz Switching Frequency
- Cycle-by-Cycle Current Limiting
- Overtemperature Protection
- Internal Soft-Start
- Start-up with Pre-Biased Output Load
- Adjustable Output Voltage Down to 0.8 V
- Power Saving Mode During Light Load
- These are Pb-Free Devices

Applications

- DSP Power
- Hard Disk Drivers
- Computer Peripherals
- Home Audio
- Set-Top Boxes
- Networking Equipment
- LCD TV
- Wireless and DSL/Cable Modem
- USB Power Devices



ON Semiconductor®

<http://onsemi.com>



1
DFN6
CASE 506AH

MARKING DIAGRAM

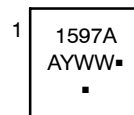

- A = Assembly Location
- Y = Year
- WW = Work Week
- = Pb-Free Package

(Note: Microdot may be in either location)

PIN CONNECTIONS

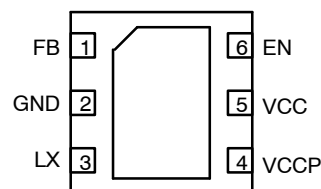

ORDERING INFORMATION

Device	Package	Shipping†
NCP1597AMNTWG	DFN6 (Pb-Free)	3000 / Tape & Reel

†For information on tape and reel specifications, including part orientation and tape sizes, please refer to our Tape and Reel Packaging Specifications Brochure, BRD8011/D.

NCP1597A

BLOCK DIAGRAM

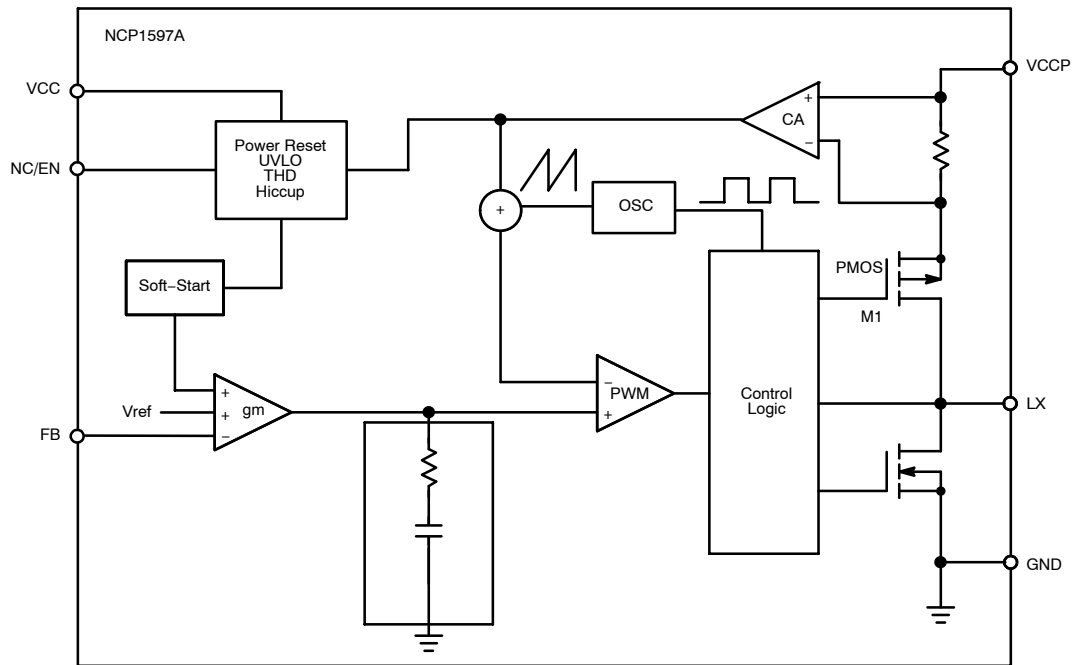

Figure 1. Block Diagram

PIN DESCRIPTIONS

Pin No	Symbol	Description
1	FB	Feedback input pin of the Error Amplifier. Connect a resistor divider from the converter's output voltage to this pin to set the converter's output voltage.
2	GND	Ground pin. Connect to thermal pad.
3	LX	The drains of the internal MOSFETs. The output inductor should be connected to this pin.
4	V _{CCP}	Power input for the power stage
5	V _{CC}	Input supply pin for internal bias circuitry. A 0.1 μ F ceramic bypass capacitor is preferred to connect to this pin.
6	EN	Logic input to enable the part. Logic high to turn on the part and logic low to shut off the part.
EP	PAD	Exposed pad of the package provides both electrical contact to the ground and good thermal contact to the PCB. This pad must be soldered to the PCB for proper operation.

NCP1597A

APPLICATION CIRCUIT

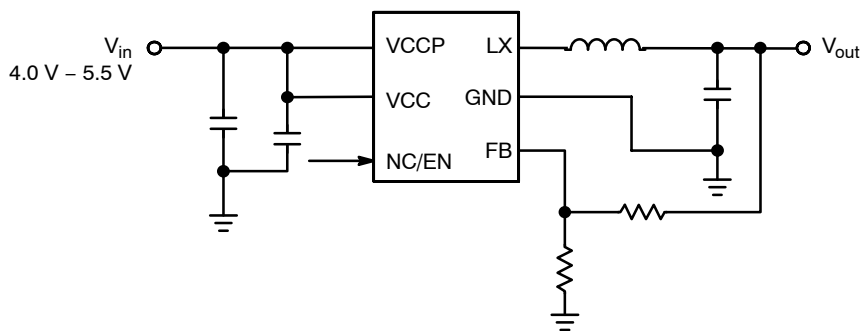

Figure 2. NCP1597A

ABSOLUTE MAXIMUM RATINGS

Rating	Symbol	Value	Unit
Power Supply Pin (Pin 4, 5) to GND	V_{in}	6.5 -0.3 (DC) -1.0 (t < 100 ns)	V
LX to GND		$V_{in} + 0.7$ $V_{in} + 1.0$ (t < 20 ns) -0.7 (DC) -5.0 (t < 100 ns)	V
All other pins		6.0 -0.3 (DC) -1.0 (t < 100 ns)	V
Operating Temperature Range	T_A	-40 to +85	°C
Junction Temperature	T_J	-40 to +150	°C
Storage Temperature Range	T_s	-55 to +150	°C
Thermal Resistance Junction-to-Air (Note 1)	$R_{\theta JA}$	68.5	°C/W

Stresses exceeding Maximum Ratings may damage the device. Maximum Ratings are stress ratings only. Functional operation above the Recommended Operating Conditions is not implied. Extended exposure to stresses above the Recommended Operating Conditions may affect device reliability.

1. $R_{\theta JA}$ measured on approximately 1x1 inch sq. of 1 oz. Copper.

NCP1597A

ELECTRICAL CHARACTERISTICS

($V_{in} = 4.0\text{ V} - 5.5\text{ V}$, $V_{out} = 1.2\text{ V}$, $T_J = +25^\circ\text{C}$ for typical value; $-40^\circ\text{C} < T_J < 85^\circ\text{C}$ for min/max values unless noted otherwise)

Parameter	Symbol	Test Conditions	Min	Typ	Max	Unit
V_{in} Input Voltage Range	V_{in}		4.0		5.5	V
V_{CC} UVLO Threshold			3.2	3.5	3.8	V
UVLO Hysteresis				335		mV
V_{CC} Quiescent Current	I_{inVCC}	$V_{in} = 5\text{ V}, V_{FB} = 1.5\text{ V}$, (No Switching)		1.7	2.0	mA
V_{CCP} Quiescent Current	I_{inVCCP}	$V_{in} = 5\text{ V}, V_{FB} = 1.5\text{ V}$, (No Switching)		25		μA
V_{in} Shutdown Supply Current (Note 2)	I_{QSHDN}	EN = 0 V		1.8	3.0	μA

FEEDBACK VOLTAGE

Reference Voltage	V_{ref}		0.788	0.800	0.812	V
Feedback Input Bias Current	I_{FB}	$V_{FB} = 0.8\text{ V}$		10	100	nA
Feedback Voltage Line Regulation		$V_{in} = 4.0\text{ V to } 5.5\text{ V}$		0.06		%/V

PWM

Maximum Duty Cycle (Regulating)			82	85		%
Minimum Controllable ON Time (Note 2)				50		ns

PULSE-BY-PULSE CURRENT LIMIT

Pulse-by-Pulse Current Limit (Regulation)	I_{LIM}		2.7	3.9	4.3	A
Pulse-by-Pulse Current Limit (Soft-Start)	I_{LIMSS}		4.0	5.3	6.1	A

OSCILLATOR

Oscillator Frequency	F_{SW}		0.87	1.0	1.13	MHz
----------------------	----------	--	------	-----	------	-----

MOSFET

High Side MOSFET ON Resistance	$R_{DS(on)HS}$	$I_{DS} = 100\text{ mA}, V_{GS} = 5\text{ V}$		140	200	$\text{m}\Omega$
High Side MOSFET Leakage (Note 2)		$V_{EN} = 0\text{ V}, V_{SW} = 0\text{ V}$			10	μA
Low Side MOSFET ON Resistance	$R_{DS(on)LS}$	$I_{DS} = 100\text{ mA}, V_{GS} = 5\text{ V}$		90	125	$\text{m}\Omega$
Low Side MOSFET Leakage (Note 2)		$V_{EN} = 0\text{ V}, V_{SW} = 5\text{ V}$			10	μA

ENABLE (NCP1597A)

EN HI Threshold	ENHI		1.4			V
EN LO Threshold	ENLO				0.4	V
EN Hysteresis				200		mV
EN Pullup Current				1.4	3.0	μA

SOFT-START

Soft-Start Ramp Time	t_{SS}	$F_{SW} = 1\text{ MHz}$		1.0		ms
Hiccup Timer				2.0		ms

THERMAL SHUTDOWN

Thermal Shutdown Threshold				185		$^\circ\text{C}$
Thermal Shutdown Hysteresis				30		$^\circ\text{C}$

2. Guaranteed by design. Not production tested.

TYPICAL OPERATING CHARACTERISTICS

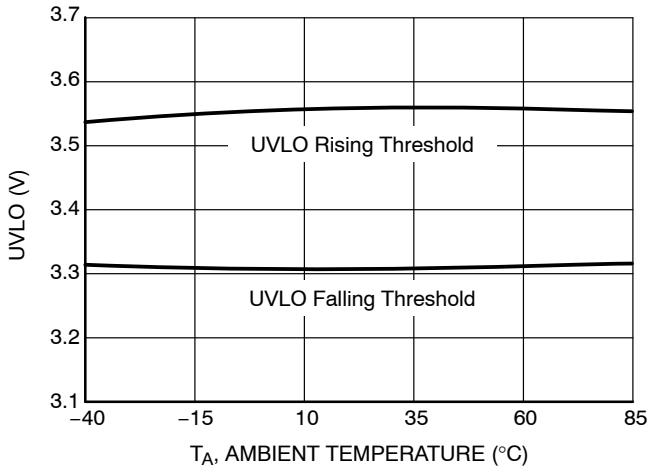

Figure 3. Undervoltage Lockout vs. Temperature

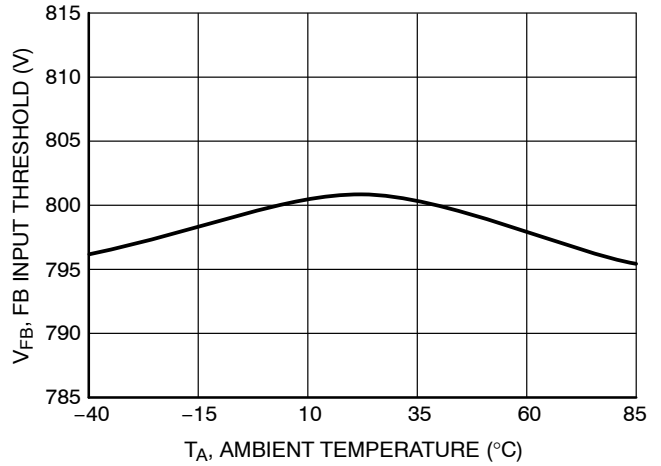

Figure 4. Feedback Input Threshold vs. Temperature

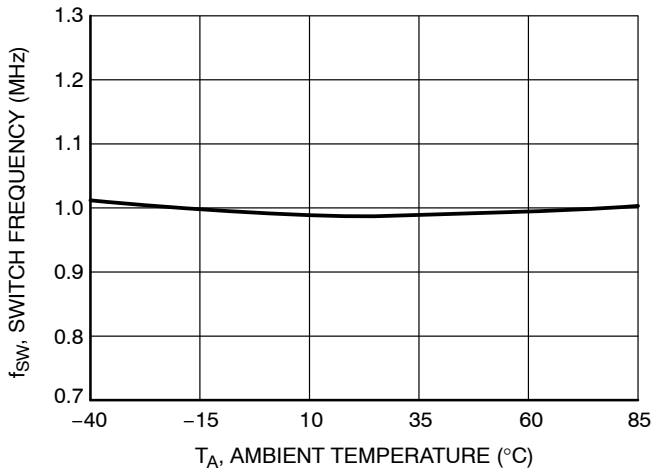

Figure 5. Switching Frequency vs. Temperature

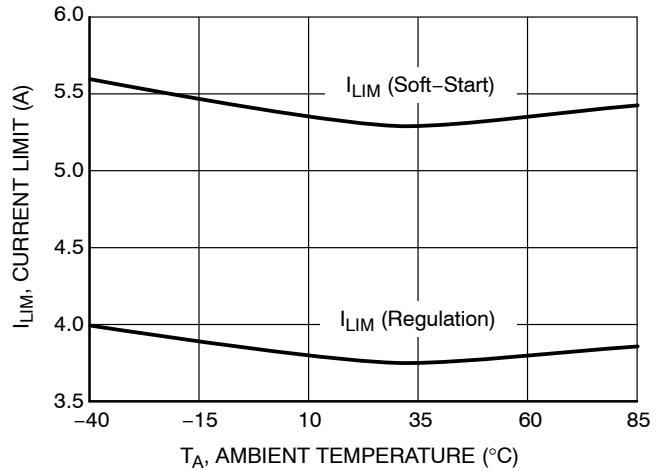

Figure 6. Current Limit vs. Temperature

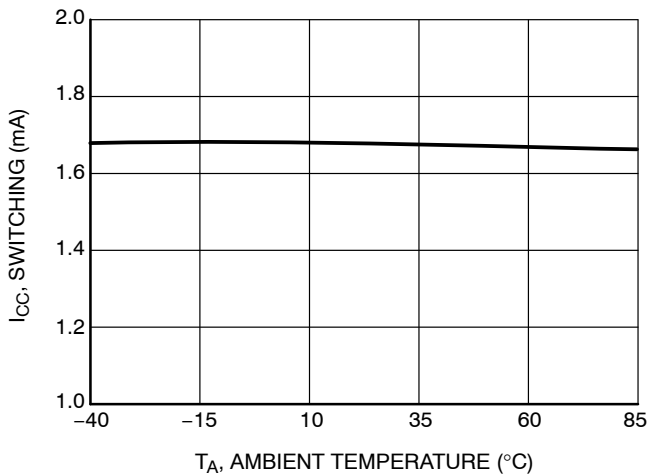

Figure 7. Quiescent Current Into V_{CC} vs. Temperature

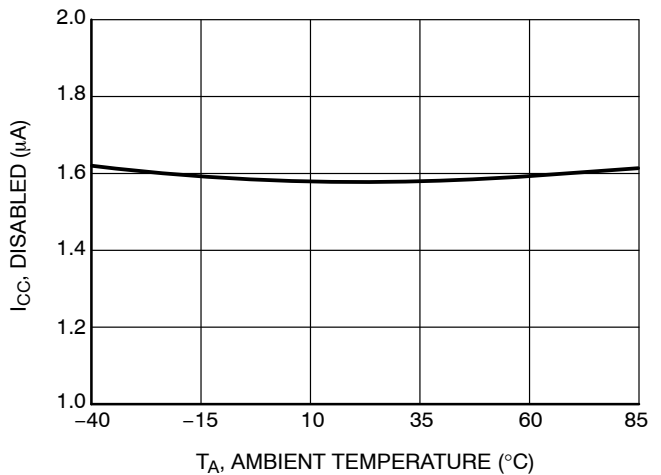

Figure 8. Quiescent Current Into V_{CC} vs. Temperature

TYPICAL OPERATING CHARACTERISTICS

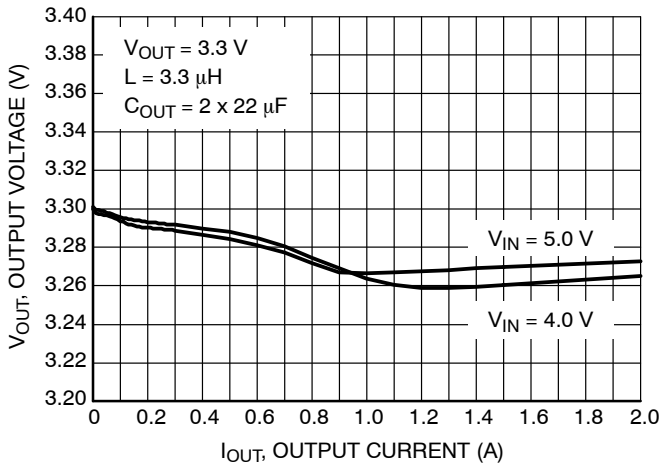

Figure 9. Load Regulation for $V_{OUT} = 3.3\text{ V}$

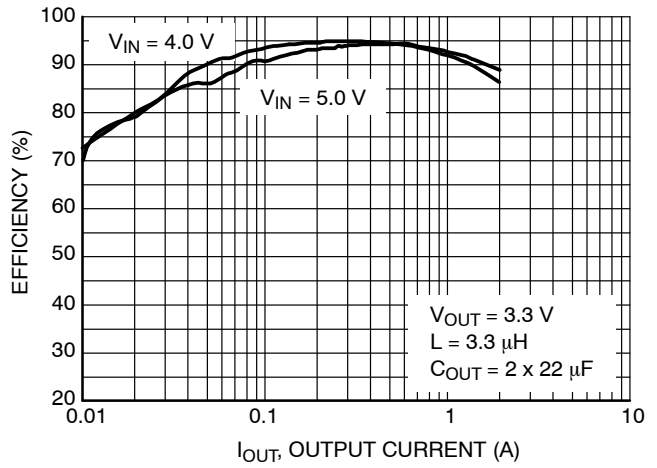

Figure 10. Efficiency vs. Output Current for $V_{OUT} = 3.3\text{ V}$

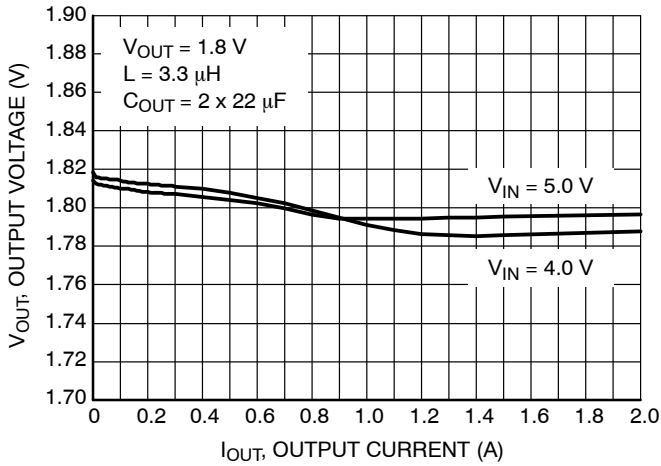

Figure 11. Load Regulation for $V_{OUT} = 1.8\text{ V}$

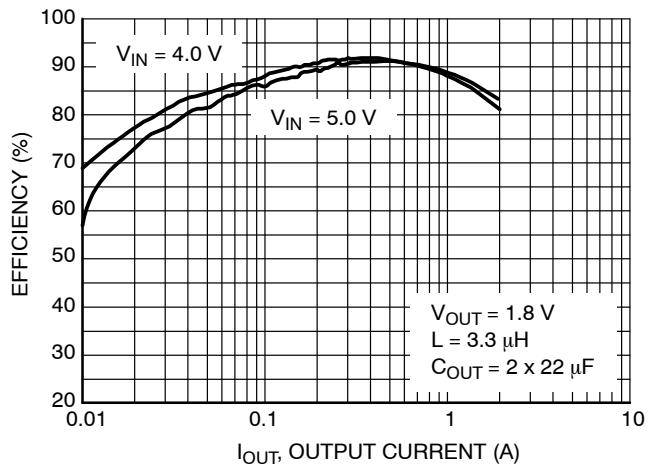

Figure 12. Efficiency vs. Output Current for $V_{OUT} = 1.8\text{ V}$

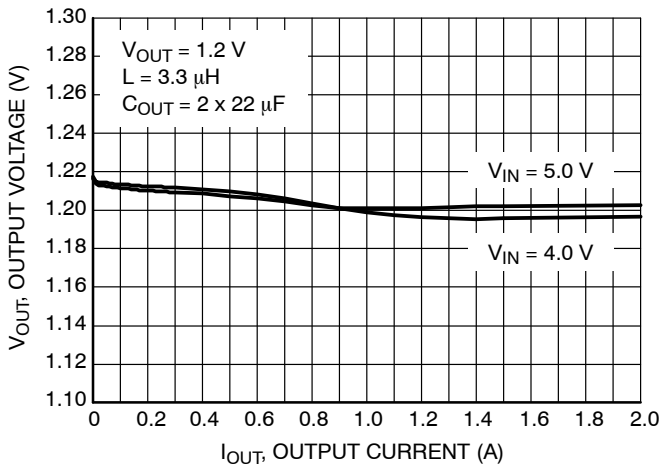

Figure 13. Load Regulation for $V_{OUT} = 1.2\text{ V}$

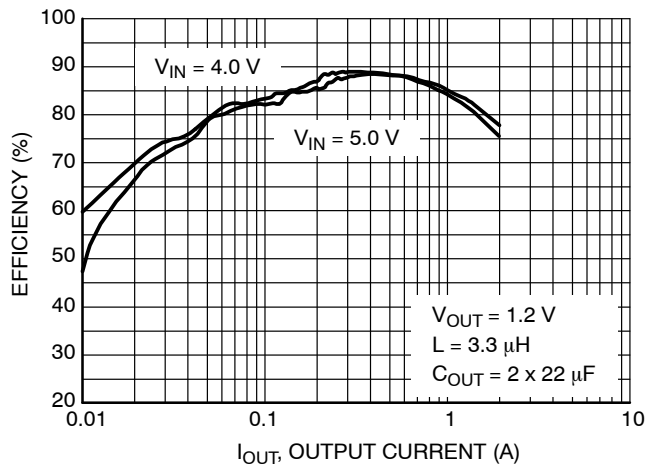
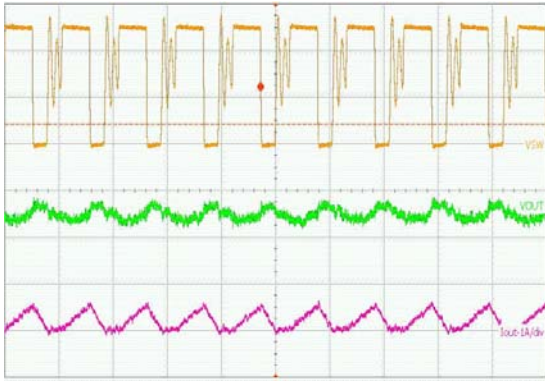
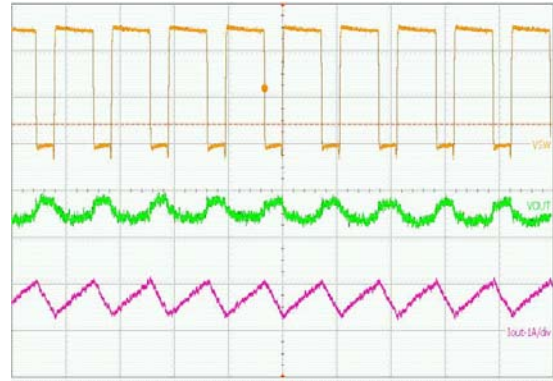

Figure 14. Efficiency vs. Output Current for $V_{OUT} = 1.2\text{ V}$



($V_{IN} = 5\text{ V}$, $I_{LOAD} = 100\text{ mA}$, $L = 3.3\text{ }\mu\text{H}$, $C_{OUT} = 2 \times 22\text{ }\mu\text{F}$)
 Upper Trace: L_X Pin Switching Waveform, 2 V/div
 Middle Trace: Output Ripple Voltage, 20 mV/div
 Lower Trace: Inductor Current, 1 A/div
 Time Scale: 1.0 $\mu\text{s/div}$

Figure 15. DCM Switching Waveform for $V_{OUT} = 3.3\text{ V}$



($V_{IN} = 5\text{ V}$, $I_{LOAD} = 700\text{ mA}$, $L = 3.3\text{ }\mu\text{H}$, $C_{OUT} = 2 \times 22\text{ }\mu\text{F}$)
 Upper Trace: L_X Pin Switching Waveform, 2 V/div
 Middle Trace: Output Ripple Voltage, 20 mV/div
 Lower Trace: Inductor Current, 1 A/div
 Time Scale: 1.0 $\mu\text{s/div}$

Figure 16. CCM Switching Waveform for $V_{OUT} = 3.3\text{ V}$

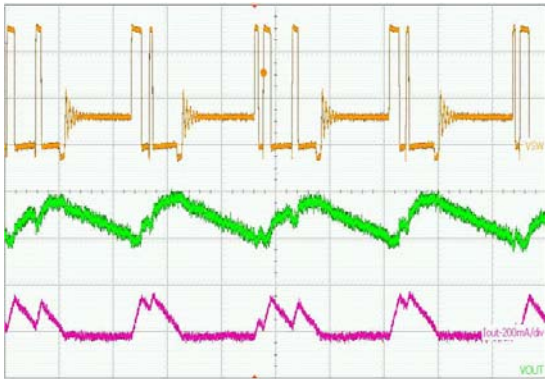

($V_{IN} = 5\text{ V}$, $I_{LOAD} = 100\text{ mA}$, $L = 3.3\text{ }\mu\text{H}$, $C_{OUT} = 2 \times 22\text{ }\mu\text{F}$)
 Upper Trace: L_X Pin Switching Waveform, 2 V/div
 Middle Trace: Output Ripple Voltage, 20 mV/div
 Lower Trace: Inductor Current, 200 mA/div
 Time Scale: 1.0 $\mu\text{s/div}$

Figure 17. DCM Switching Waveform for $V_{OUT} = 1.2\text{ V}$

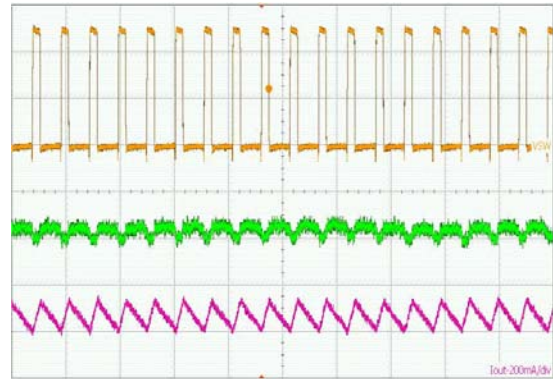

($V_{IN} = 5\text{ V}$, $I_{LOAD} = 400\text{ mA}$, $L = 3.3\text{ }\mu\text{H}$, $C_{OUT} = 2 \times 22\text{ }\mu\text{F}$)
 Upper Trace: L_X Pin Switching Waveform, 2 V/div
 Middle Trace: Output Ripple Voltage, 20 mV/div
 Lower Trace: Inductor Current, 1 A/div
 Time Scale: 1.0 $\mu\text{s/div}$

Figure 18. CCM Switching Waveform for $V_{OUT} = 1.2\text{ V}$

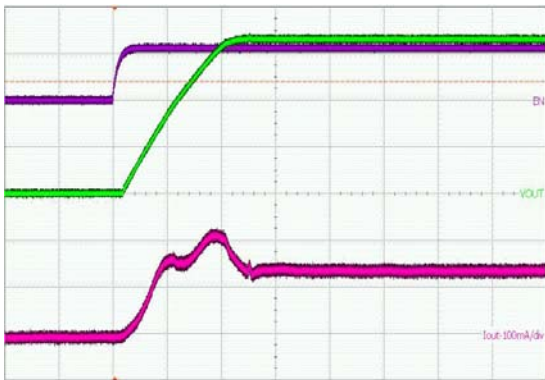

($V_{IN} = 5\text{ V}$, $I_{LOAD} = 100\text{ mA}$, $L = 3.3\text{ }\mu\text{H}$, $C_{OUT} = 2 \times 22\text{ }\mu\text{F}$)
 Upper Trace: EN Pin Voltage, 2 V/div
 Middle Trace: Output Voltage, 1 V/div
 Lower Trace: Inductor Current, 100 mA/div
 Time Scale: 500 $\mu\text{s/div}$

Figure 19. Soft-Start Waveforms for $V_{OUT} = 3.3\text{ V}$

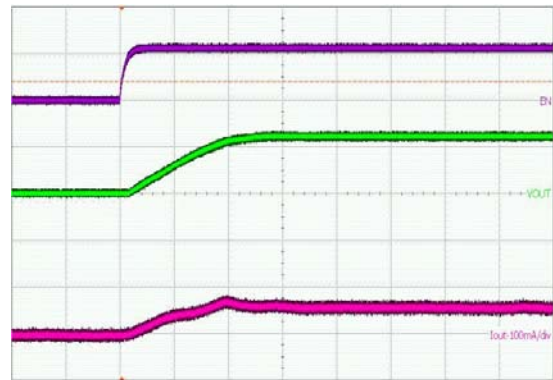

($V_{IN} = 5\text{ V}$, $I_{LOAD} = 100\text{ mA}$, $L = 3.3\text{ }\mu\text{H}$, $C_{OUT} = 2 \times 22\text{ }\mu\text{F}$)
 Upper Trace: EN Pin Voltage, 2 V/div
 Middle Trace: Output Voltage, 1 V/div
 Lower Trace: Inductor Current, 100 mA/div
 Time Scale: 500 $\mu\text{s/div}$

Figure 20. Soft-Start Waveforms for $V_{OUT} = 1.2\text{ V}$

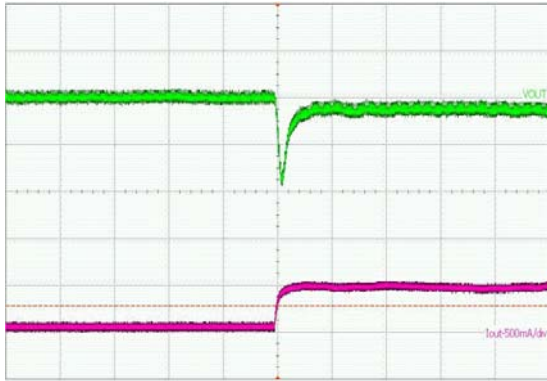

($V_{IN} = 5\text{ V}$, $I_{LOAD} = 100\text{ mA}$, $L = 3.3\text{ }\mu\text{H}$, $C_{OUT} = 2 \times 22\text{ }\mu\text{F}$)
 Upper Trace: Output Dynamic Voltage, 100 mV/div
 Lower Trace: Output Current, 500 mA/div
 Time Scale: 200 $\mu\text{s}/\text{div}$

Figure 21. Transient Response for $V_{OUT} = 3.3\text{ V}$

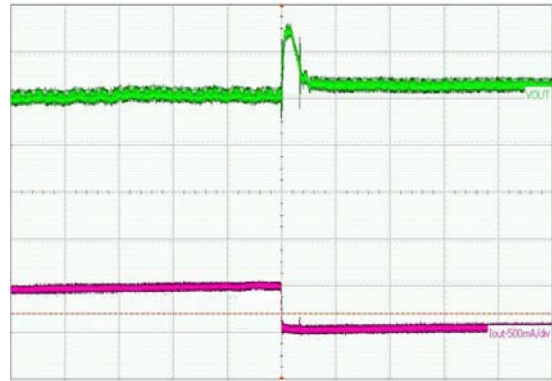

($V_{IN} = 5\text{ V}$, $I_{LOAD} = 100\text{ mA}$, $L = 3.3\text{ }\mu\text{H}$, $C_{OUT} = 2 \times 22\text{ }\mu\text{F}$)
 Upper Trace: Output Dynamic Voltage, 100 mV/div
 Lower Trace: Output Current, 500 mA/div
 Time Scale: 200 $\mu\text{s}/\text{div}$

Figure 22. Transient Response for $V_{OUT} = 3.3\text{ V}$

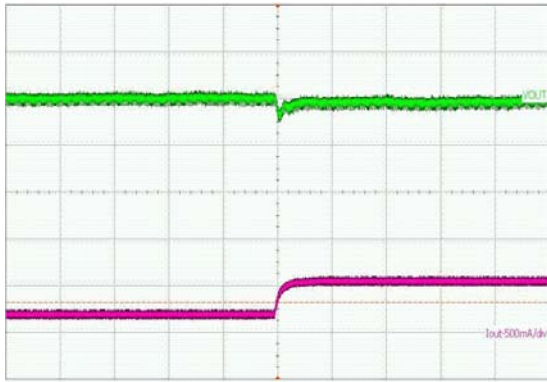

($V_{IN} = 5\text{ V}$, $I_{LOAD} = 100\text{ mA}$, $L = 3.3\text{ H}$, $C_{OUT} = 2 \times 22\text{ }\mu\text{F}$)
 Upper Trace: Output Dynamic Voltage, 100 mV/div
 Lower Trace: Output Current, 500 mA/div
 Time Scale: 200 $\mu\text{s}/\text{div}$

Figure 23. Transient Response for $V_{OUT} = 1.2\text{ V}$

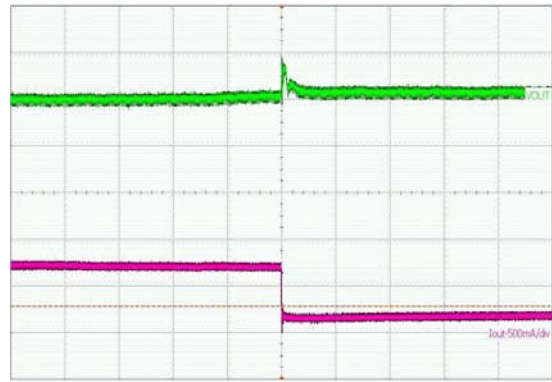

($V_{IN} = 5\text{ V}$, $I_{LOAD} = 100\text{ mA}$, $L = 3.3\text{ H}$, $C_{OUT} = 2 \times 22\text{ }\mu\text{F}$)
 Upper Trace: Output Dynamic Voltage, 100 mV/div
 Lower Trace: Output Current, 500 mA/div
 Time Scale: 200 $\mu\text{s}/\text{div}$

Figure 24. Transient Response for $V_{OUT} = 1.2\text{ V}$

NCP1597A

DETAILED DESCRIPTION

Overview

The NCP1597A is a synchronous PWM controller that incorporates all the control and protection circuitry necessary to satisfy a wide range of applications. The NCP1597A employs current mode control to provide fast transient response, simple compensation, and excellent stability. The features of the NCP1597A include a precision reference, fixed 1 MHz switching frequency, a transconductance error amplifier, an integrated high-side P-channel MOSFET and low-side N-channel MOSFET, internal soft-start, and very low shutdown current. The protection features of the NCP1597A include internal soft-start, pulse-by-pulse current limit, and thermal shutdown.

Reference Voltage

The NCP1597A incorporates an internal reference that allows output voltages as low as 0.8 V. The tolerance of the internal reference is guaranteed over the entire operating temperature range of the controller. The reference voltage is trimmed using a test configuration that accounts for error amplifier offset and bias currents.

Oscillator Frequency

A fixed precision oscillator is provided. The oscillator frequency range is 1 MHz with $\pm 13\%$ variation.

Transconductance Error Amplifier

The transconductance error amplifier's primary function is to regulate the converter's output voltage using a resistor divider connected from the converter's output to the FB pin of the controller, as shown in the applications Schematic. If a Fault occurs, the amplifier's output is immediately pulled to GND and PWM switching is inhibited.

Internal Soft-Start

To limit the startup inrush current, an internal soft start circuit is used to ramp up the reference voltage from 0 V to its final value linearly. The internal soft start time is 1 ms typically.

Output MOSFETs

The NCP1597A includes low $R_{DS(on)}$, both high-side P-channel and low-side N-channel MOSFETs capable of

delivering up to 2.0 A of current. When the controller is disabled or during a Fault condition, the controller's output stage is tri-stated by turning OFF both the upper and lower MOSFETs.

Adaptive Dead Time Gate Driver

In a synchronous buck converter, a certain dead time is required between the low side drive signal and high side drive signal to avoid shoot through. During the dead time, the body diode of the low side FET freewheels the current. The body diode has much higher voltage drop than that of the MOSFET, which reduces the efficiency significantly. The longer the body diode conducts, the lower the efficiency. In NCP1597A, the drivers and MOSFETs are integrated in a single chip. The parasitic inductance is minimized. Adaptive dead time control method is used in NCP1597A to prevent the shoot through from happening and minimizing the diode conduction loss at the same time.

Pulse Width Modulation

A high-speed PWM comparator, capable of pulse widths as low as 50 ns, is included in the NCP1597A. The inverting input of the comparator is connected to the output of the error amplifier. The non-inverting input is connected to the current sense signal. At the beginning of each PWM cycle, the CLK signal sets the PWM flip-flop and the upper MOSFET is turned ON. When the current sense signal rises above the error amplifier's voltage then the comparator will reset the PWM flip-flop and the upper MOSFET will be turned OFF.

Power Save Mode

If the load current decreases, the converter will enter power save mode operation automatically. During power save mode, the converter skips switching and operates with reduced frequency, which minimizes the quiescent current and maintain high efficiency.

Current Sense

The NCP1597A monitors the current in the upper MOSFET. The current signal is required by the PWM comparator and the pulse-by-pulse current limiter.

NCP1597A

PROTECTIONS

Undervoltage Lockout (UVLO)

The under voltage lockout feature prevents the controller from switching when the input voltage is too low to power the internal power supplies and reference. Hysteresis must be incorporated in the UVLO comparator to prevent IxR drops in the wiring or PCB traces from causing ON/OFF cycling of the controller during heavy loading at power up or power down.

Overcurrent Protection (OCP)

NCP1597A detects high side switch current and then compares to a voltage level representing the overcurrent threshold limit. If the current through the high side FET exceeds the overcurrent threshold limit for seven consecutive switching cycles, overcurrent protection is triggered.

Once the overcurrent protection occurs, hiccup mode engages. First, hiccup mode, turns off both FETs and discharges the internal compensation network at the output of the OTA. Next, the IC waits typically 2 ms and then resets the overcurrent counter. After this reset, the circuit attempts another normal soft-start. During soft-start, the overcurrent protection threshold is increased to prevent false

overcurrent detection while charging the output capacitors. Hiccup mode reduces input supply current and power dissipation during a short circuit. It also allows for much improved system up-time, allowing auto-restart upon removal of a temporary short-circuit.

Pre-Bias Startup

In some applications the controller will be required to start switching when it's output capacitors are charged anywhere from slightly above 0 V to just below the regulation voltage. This situation occurs for a number of reasons: the converter's output capacitors may have residual charge on them or the converter's output may be held up by a low current standby power supply. NCP1597A supports pre-bias start up by holding Low side FETs off till soft start ramp reaches the FB Pin voltage.

Thermal Shutdown

The NCP1597A protects itself from over heating with an internal thermal monitoring circuit. If the junction temperature exceeds the thermal shutdown threshold both the upper and lower MOSFETs will be shut OFF.

APPLICATION INFORMATION

Programming the Output Voltage

The output voltage is set using a resistive voltage divider from the output voltage to FB pin (see Figure 25). So the output voltage is calculated according to Eq.1.

$$V_{out} = V_{FB} \cdot \frac{R_1 + R_2}{R_2} \quad (\text{eq. 1})$$

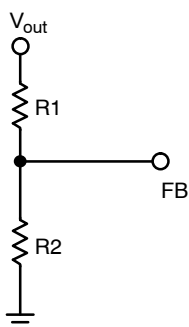

Figure 25. Output divider

Inductor Selection

The inductor is the key component in the switching regulator. The selection of inductor involves trade-offs among size, cost and efficiency. The inductor value is selected according to the equation 2.

$$L = \frac{V_{out}}{f \cdot I_{ripple}} \cdot \left(1 - \frac{V_{out}}{V_{in(max)}} \right) \quad (\text{eq. 2})$$

Where V_{out} – the output voltage;

f – switching frequency, 1.0 MHz;

I_{ripple} – Ripple current, usually it's 20% – 30% of output current;

$V_{in(max)}$ – maximum input voltage.

Choose a standard value close to the calculated value to maintain a maximum ripple current within 30% of the maximum load current. If the ripple current exceeds this 30% limit, the next larger value should be selected.

The inductor's RMS current rating must be greater than the maximum load current and its saturation current should be about 30% higher. For robust operation in fault conditions (start-up or short circuit), the saturation current should be high enough. To keep the efficiency high, the series resistance (DCR) should be less than 0.1 Ω , and the core material should be intended for high frequency applications.

Output Capacitor Selection

The output capacitor acts to smooth the dc output voltage and also provides energy storage. So the major parameter necessary to define the output capacitor is the maximum allowed output voltage ripple of the converter. This ripple is related to capacitance and the ESR. The minimum capacitance required for a certain output ripple can be calculated by Equation 4.

$$C_{OUT(min)} = \frac{I_{ripple}}{8 \cdot f \cdot V_{ripple}} \quad (\text{eq. 3})$$

Where V_{ripple} is the allowed output voltage ripple.

The required ESR for this amount of ripple can be calculated by equation 5.

$$ESR = \frac{V_{ripple}}{I_{ripple}} \quad (\text{eq. 4})$$

Based on Equation 2 to choose capacitor and check its ESR according to Equation 3. If ESR exceeds the value from Eq.4, multiple capacitors should be used in parallel.

Ceramic capacitor can be used in most of the applications. In addition, both surface mount tantalum and through-hole aluminum electrolytic capacitors can be used as well.

Maximum Output Capacitor

NCP1597A family has internal 1 ms fixed soft-start and overcurrent limit. It limits the maximum allowed output capacitor to startup successfully. The maximum allowed output capacitor can be determined by the equation:

$$C_{out(max)} = \frac{I_{lim(min)} - I_{load(max)} - \frac{\Delta i_{p-p}}{2}}{V_{out}/T_{SS(min)}} \quad (\text{eq. 5})$$

Where $T_{SS(min)}$ is the minimum soft-start period (1ms); Δi_{pp} is the current ripple.

This is assuming that a constant load is connected. For example, with 3.3 V/2.0 A output and 20% ripple, the max allowed output capacitors is 546 μ F.

Input Capacitor Selection

The input capacitor can be calculated by Equation 6.

$$C_{in(min)} = I_{out(max)} \cdot D_{max} \cdot \frac{1}{f \cdot V_{in(ripple)}} \quad (\text{eq. 6})$$

Where $V_{in(ripple)}$ is the required input ripple voltage.

$$D_{max} = \frac{V_{out}}{V_{in(min)}} \text{ is the maximum duty cycle.} \quad (\text{eq. 7})$$

Power Dissipation

The NCP1597A is available in a thermally enhanced 6-pin, DFN package. When the die temperature reaches +185°C, the NCP1597A shuts down (see the *Thermal-Overload Protection* section). The power dissipated in the device is the sum of the power dissipated from supply current (PQ), power dissipated due to switching the internal power MOSFET (P_{sw}), and the power dissipated due to the RMS current through the internal power MOSFET (PON). The total power dissipated in the package must be limited so the junction temperature does not exceed its absolute maximum rating of +150°C at

maximum ambient temperature. Calculate the power lost in the NCP1597A using the following equations:

1. High side MOSFET

The conduction loss in the top switch is:

$$P_{HSON} = I_{RMS_HSFET}^2 \times R_{DS(on)HS} \quad (\text{eq. 8})$$

Where:

$$I_{RMS_FET} = \sqrt{\left(I_{out}^2 + \frac{\Delta I_{PP}^2}{12}\right) \times D} \quad (\text{eq. 9})$$

ΔI_{PP} is the peak-to-peak inductor current ripple.

The power lost due to switching the internal power high side MOSFET is:

$$P_{HSSW} = \frac{V_{in} \cdot I_{out} \cdot (t_r + t_f) \cdot f_{SW}}{2} \quad (\text{eq. 10})$$

t_r and t_f are the rise and fall times of the internal power MOSFET measured at SW node.

2. Low side MOSFET

The power dissipated in the top switch is:

$$P_{LSON} = I_{RMS_LSFET}^2 \cdot R_{DS(on)LS} \quad (\text{eq. 11})$$

Where:

$$I_{RMS_LSFET} = \sqrt{\left(I_{out}^2 + \frac{\Delta I_{PP}^2}{12}\right) \cdot (1 - D)} \quad (\text{eq. 12})$$

ΔI_{PP} is the peak-to-peak inductor current ripple.

The switching loss for the low side MOSFET can be ignored.

The power lost due to the quiescent current (I_Q) of the device is:

$$P_Q = V_{in} \cdot I_Q \quad (\text{eq. 13})$$

I_Q is the switching quiescent current of the NCP1597A.

$$P_{TOTAL} = P_{HSON} + P_{HSSW} + P_{LSON} + P_Q \quad (\text{eq. 14})$$

Calculate the temperature rise of the die using the following equation:

$$T_J = T_C + (P_{TOTAL} \cdot \theta_{JC}) \quad (\text{eq. 15})$$

θ_{JC} is the junction-to-case thermal resistance equal to 1.7°C/W. T_C is the temperature of the case and T_J is the junction temperature, or die temperature. The case-to-ambient thermal resistance is dependent on how well heat can be transferred from the PC board to the air. Solder the underside-exposed pad to a large copper GND plane. If the die temperature reaches the thermal shutdown threshold the NCP1597A shut down and does not restart again until the die temperature cools by 30°C.

Layout Consideration

As with all high frequency switchers, when considering layout, care must be taken in order to achieve optimal electrical, thermal and noise performance. For 1.0MHz switching frequency, switch rise and fall times are typically in few nanosecond range. To prevent noise both radiated and conducted the high speed switching current path must be kept as short as possible. Shortening the current path will also reduce the parasitic trace inductance of approximately 25 nH/inch. At switch off, this parasitic inductance produces a flyback spike across the NCP1597A switch. When operating at higher currents and input voltages, with poor layout, this spike can generate voltages across the NCP1597A that may exceed its absolute maximum rating. A ground plane should always be used under the switcher circuitry to prevent interplane coupling and overall noise.

The FB component should be kept as far away as possible from the switch node. The ground for these components should be separated from the switch current path. Failure to do so will result in poor stability or subharmonic like oscillation.

Board layout also has a significant effect on thermal resistance. Reducing the thermal resistance from ground pin and exposed pad onto the board will reduce die temperature and increase the power capability of the NCP1597A. This is achieved by providing as much copper area as possible around the exposed pad. Adding multiple thermal vias under and around this pad to an internal ground plane will also help. Similar treatment to the inductor pads will reduce any additional heating effects.

NCP1597A

PACKAGE DIMENSIONS

DFN6 3x3, 0.95P
CASE 506AH-01
ISSUE O

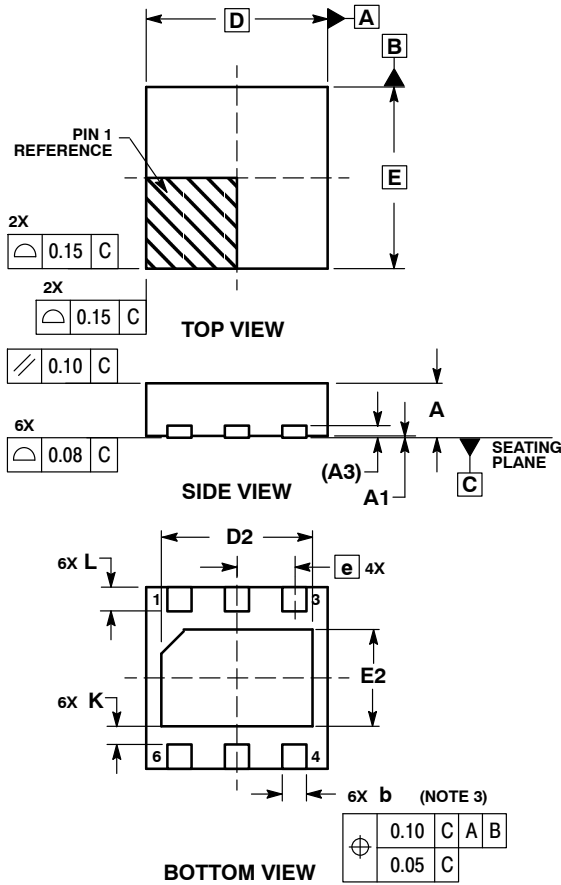

NOTES:

1. DIMENSIONS AND TOLERANCING PER ASME Y14.5M, 1994.
2. CONTROLLING DIMENSION: MILLIMETERS.
3. DIMENSION b APPLIES TO PLATED TERMINAL AND IS MEASURED BETWEEN 0.25 AND 0.30 MM FROM TERMINAL.
4. COPLANARITY APPLIES TO THE EXPOSED PAD AS WELL AS THE TERMINALS.

MILLIMETERS			
DIM	MIN	NOM	MAX
A	0.80	0.90	1.00
A1	0.00	0.03	0.05
A3	0.20 REF		
b	0.35	0.40	0.45
D	3.00 BSC		
D2	2.40	2.50	2.60
E	3.00 BSC		
E2	1.50	1.60	1.70
e	0.95 BSC		
K	0.21	---	---
L	0.30	0.40	0.50

SOLDERING FOOTPRINT*

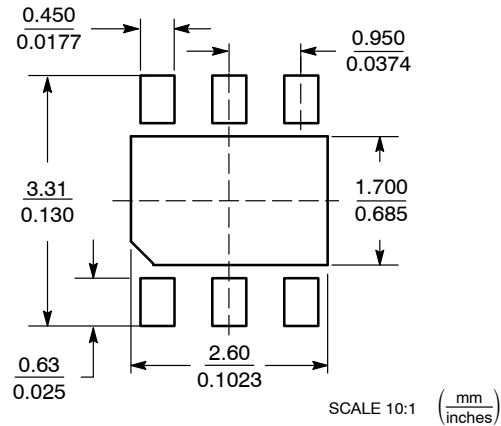

*For additional information on our Pb-Free strategy and soldering details, please download the ON Semiconductor Soldering and Mounting Techniques Reference Manual, SOLDERRM/D.

ON Semiconductor and are registered trademarks of Semiconductor Components Industries, LLC (SCILLC). SCILLC reserves the right to make changes without further notice to any products herein. SCILLC makes no warranty, representation or guarantee regarding the suitability of its products for any particular purpose, nor does SCILLC assume any liability arising out of the application or use of any product or circuit, and specifically disclaims any and all liability, including without limitation special, consequential or incidental damages. "Typical" parameters which may be provided in SCILLC data sheets and/or specifications can and do vary in different applications and actual performance may vary over time. All operating parameters, including "Typicals" must be validated for each customer application by customer's technical experts. SCILLC does not convey any license under its patent rights nor the rights of others. SCILLC products are not designed, intended, or authorized for use as components in systems intended for surgical implant into the body, or other applications intended to support or sustain life, or for any other application in which the failure of the SCILLC product could create a situation where personal injury or death may occur. Should Buyer purchase or use SCILLC products for any such unintended or unauthorized application, Buyer shall indemnify and hold SCILLC and its officers, employees, subsidiaries, affiliates, and distributors harmless against all claims, costs, damages, and expenses, and reasonable attorney fees arising out of, directly or indirectly, any claim of personal injury or death associated with such unintended or unauthorized use, even if such claim alleges that SCILLC was negligent regarding the design or manufacture of the part. SCILLC is an Equal Opportunity/Affirmative Action Employer. This literature is subject to all applicable copyright laws and is not for resale in any manner.

PUBLICATION ORDERING INFORMATION

LITERATURE FULFILLMENT:
Literature Distribution Center for ON Semiconductor
P.O. Box 5163, Denver, Colorado 80217 USA
Phone: 303-675-2175 or 800-344-3860 Toll Free USA/Canada
Fax: 303-675-2176 or 800-344-3867 Toll Free USA/Canada
Email: orderlit@onsemi.com

N. American Technical Support: 800-282-9855 Toll Free USA/Canada
Europe, Middle East and Africa Technical Support:
Phone: 421 33 790 2910
Japan Customer Focus Center
Phone: 81-3-5773-3850

ON Semiconductor Website: www.onsemi.com
Order Literature: <http://www.onsemi.com/orderlit>
For additional information, please contact your local Sales Representative